

**REMstar Pro C-Flex +**

USER MANUAL

  
**RESPIRONICS**



# Table of Contents

|   |           |
|---|-----------|
| Intended Use.....                       | 2         |
| Important.....                          | 2         |
| Warnings.....                           | 2         |
| Cautions.....                           | 3         |
| Contraindications .....                 | 3         |
| Symbol Key.....                         | 3         |
| System Contents.....                    | 4         |
| System Overview.....                    | 4         |
| Control Buttons.....                    | 5         |
| Available Therapies .....               | 5         |
| Installing the Air Filters.....         | 6         |
| Connecting the Breathing Circuit.....   | 6         |
| Where to Place the Device.....          | 6         |
| Supplying AC Power to the Device.....   | 7         |
| Navigating the Device Screens.....      | 7         |
| Starting the Device.....                | 7         |
| Ramp Feature.....                       | 8         |
| Flex Screen .....                       | 8         |
| Setup Screen .....                      | 8         |
| Info Screen.....                        | 10        |
| Device Alerts .....                     | 11        |
| Troubleshooting .....                   | 14        |
| Accessories .....                       | 15        |
| Traveling with the System .....         | 16        |
| Cleaning the Device .....               | 16        |
| Cleaning or Replacing the Filters ..... | 16        |
| Cleaning the Tubing.....                | 16        |
| Service.....                            | 16        |
| Specifications .....                    | 17        |
| Disposal.....                           | 18        |
| How to Contact Respirationics .....     | 18        |
| EMC Information .....                   | 19        |
| Limited Warranty.....                   | Back Page |

**CAUTION:** U. S. federal law restricts this device to sale by or on the order of a physician.

## Intended Use

The Respironics REMstar Pro C-Flex+ system delivers positive airway pressure therapy for the treatment of Obstructive Sleep Apnea in spontaneously breathing patients weighing over 30kg (66 lbs). It is for use in the home or hospital/institutional environment.

## Important

The device is to be used only on the instruction of a licensed physician. Your home care provider will make the correct pressure settings according to your health care professional's prescription.

Several accessories are available to make your OSA treatment with the REMstar Pro C-Flex+ system as convenient and comfortable as possible. To ensure that you receive the safe, effective therapy prescribed for you, use only Respironics accessories.

## Warnings

*A warning indicates the possibility of injury to the user or the operator.*

- This manual serves as a reference. The instructions in this manual are not intended to supersede the health care professional's instructions regarding the use of the device.
- The operator should read and understand this entire manual before using the device.
- This device is not intended for life support.
- The device should be used only with masks and connectors recommended by Respironics or with those recommended by the health care professional or respiratory therapist. A mask should not be used unless the device is turned on and operating properly. The exhalation port(s) associated with the mask should never be blocked. **Explanation of the Warning:** The device is intended to be used with special masks or connectors that have exhalation ports to allow continuous flow of air out of the mask. When the device is turned on and functioning properly, new air from the device flushes the exhaled air out through the mask exhalation port. However, when the device is not operating, enough fresh air will not be provided through the mask, and exhaled air may be rebreathed. Rebreathing of exhaled air for longer than several minutes can in some circumstances lead to suffocation.
- When using oxygen with this system, the oxygen supply must comply with local regulations for medical oxygen.
- When using oxygen with this system, turn the device on before turning on the oxygen. Turn the oxygen off before turning the device off. This will prevent oxygen accumulation in the device.. **Explanation of the Warning:** When the device is not in operation and the oxygen flow is left on, oxygen delivered into the tubing may accumulate within the device's enclosure. Oxygen accumulated in the device enclosure will create a risk of fire.
- When using oxygen with this system, a Respironics Pressure Valve must be placed in-line with the patient circuit after the oxygen source. Failure to use the pressure valve could result in a fire hazard.
- Do not connect the device to an unregulated or high pressure oxygen source.
- Do not use the device in the presence of a flammable anaesthetic mixture in combination with oxygen or air, or in the presence of nitrous oxide.
- Do not use the device near a source of toxic or harmful vapors.
- Do not use this device if the room temperature is warmer than 35° C (95° F). If the device is used at room temperatures warmer than 35° C (95° F), the temperature of the airflow may exceed 43° C (109° F). This could cause irritation or injury to your airway.
- Do not operate the device in direct sunlight or near a heating appliance because these conditions can increase the temperature of the air coming out of the device.
- Contact your health care professional if symptoms of sleep apnea recur.
- If you notice any unexplained changes in the performance of this device, if it is making unusual or harsh sounds, if it has been dropped or mishandled, if water is spilled into the enclosure, or if the enclosure is broken, disconnect the power cord and discontinue use. Contact your home care provider.
- Repairs and adjustments must be performed by Respironics-authorized service personnel only. Unauthorized service could cause injury, invalidate the warranty, or result in costly damage.
- Periodically inspect electrical cords and cables for damage or signs of wear. Discontinue use and replace if damaged.
- To avoid electrical shock, always unplug the power cord from the wall outlet before cleaning the device. **DO NOT** immerse the device in any fluids.
- If the device is used by multiple persons (such as rental devices), a low-resistance, main flow bacteria filter should be installed in-line between the device and the circuit tubing to prevent contamination.
- Be sure to route the power cord to the outlet in a way that will prevent the cord from being tripped over or interfered with by chairs or other furniture.
- This device is activated when the power cord is connected.

**Note:** Please see the "Limited Warranty" section of this manual for information on warranty coverage.

## Cautions

A Caution indicates the possibility of damage to the device.

- Pins of connectors should not be touched. Connections should not be made to these connectors unless ESD precautionary procedures are used. Precautionary procedures include methods to prevent build-up of electrostatic charge (e.g., air conditioning, humidification, conductive floor coverings, non-synthetic clothing), discharging one's body to the frame of the equipment or system or to earth or a large metal object, and bonding oneself by means of a wrist strap to the equipment or system or to earth.
- Condensation may damage the device. If this device has been exposed to either very hot or very cold temperatures, allow it to adjust to room temperature (operating temperature) before starting therapy. Do not operate the device outside of the operating temperature range shown in the Specifications.
- Do not use extension cords with this device.
- Do not place the device directly onto carpet, fabric, or other flammable materials.
- Do not place the device in or on any container that can collect or hold water.
- A properly installed, undamaged reusable foam inlet filter is required for proper operation.
- Tobacco smoke may cause tar build-up within the device, which may result in the device malfunctioning.
- Dirty inlet filters may cause high operating temperatures that may affect device performance. Regularly examine the inlet filters as needed for integrity and cleanliness.
- Never install a wet filter into the device. You must ensure sufficient drying time for the cleaned filter.
- When DC power is obtained from a vehicle battery, the device should not be used while the vehicle's engine is running. Damage to the device may occur.
- Only use a Respiration DC Power Cord and Battery Adapter Cable. Use of any other system may cause damage to the device.

## Contraindications







When assessing the relative risks and benefits of using this equipment, the clinician should understand that this device can deliver pressures up to 20 cm H<sub>2</sub>O. In the event of certain fault conditions, a maximum pressure of 30 cm H<sub>2</sub>O is possible. Studies have shown that the following pre-existing conditions may contraindicate the use of CPAP therapy for some patients:

- Bullous Lung Disease
- Pathologically Low Blood Pressure
- Bypassed Upper Airway
- Pneumothorax
- Pneumocephalus has been reported in a patient using nasal Continuous Positive Airway Pressure. Caution should be used when prescribing CPAP for susceptible patients such as those with: cerebral spinal fluid (CSF) leaks, abnormalities of the cribriform plate, prior history of head trauma, and/or pneumocephalus. (Chest 1989; 96:1425-1426)

The use of positive airway pressure therapy may be temporarily contraindicated if you exhibit signs of a sinus or middle ear infection. Not for use with patients whose upper airways are bypassed. Contact your health care professional if you have any questions concerning your therapy.

## Symbol Key

The following symbols may appear on the device and power supply:

| SYMBOL  | DEFINITION                                 | SYMBOL  | DEFINITION   |
|---|--|---|--|
|  | Consult accompanying instructions for use. |  | Separate collection for electrical and electronic equipment per EC Directive 2002/96/EC. |
|  | DC Power                                   | <b>IPX1</b>   | Drip Proof Equipment   |
|  | Type BF Applied Part                       |  | For Indoor Use Only  |
|  | Class II (Double Insulated)                |  | Do not disassemble.  |

## System Contents

Your REMstar Pro C-Flex+ system includes the following items:

- Device
- User manual
- Carrying case
- Flexible tubing
- Power cord and power supply
- Side cover panel
- SD card
- Reusable gray foam filter
- Disposable ultra-fine filter (optional)
- Humidifier (optional)

**Note:** If any of these items are missing, contact your home care provider.

## System Overview

The REMstar Pro C-Flex+ is a CPAP (Continuous Positive Airway Pressure) device designed for the treatment of Obstructive Sleep Apnea (OSA). CPAP maintains a constant level of pressure throughout the breathing cycle.

When prescribed for you, the device provides several special features to help make your therapy more comfortable. The ramp function allows you to lower the pressure when you are trying to fall asleep. The air pressure will gradually increase until your prescription pressure is reached. You also have the option of not using the ramp feature at all.

Additionally, the C-Flex and C-Flex+ comfort features provide you with pressure relief when you exhale during therapy.

Several accessories are also available for use with your REMstar Pro device. Contact your home care provider to purchase any accessories not included with your system.

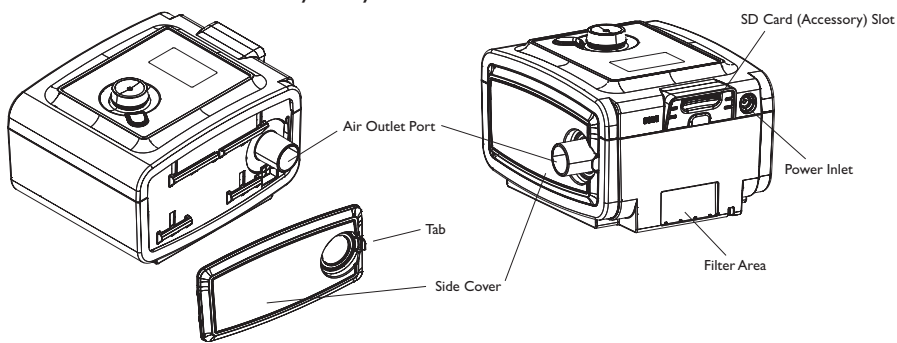

This figure illustrates some of the device features, described in the following table.

| DEVICE FEATURE                      | DESCRIPTION  |
|-------------------------------------|--|
| Air Outlet Port<br>(conical, 22 mm) | Connect the flexible tubing here.  |
| SD Card (Accessory) Slot            | If applicable, insert the optional accessory SD card here.   |
| Power Inlet                         | Connect the power cord here.   |
| Filter Area                         | A reusable, gray foam filter must be placed in the filter area to screen out normal household dust and pollens. An optional, white ultra-fine filter can also be used for more complete filtration of very fine particles. |
| Side Cover                          | If using a humidifier with the device, this side cover can be easily removed with the release tab before attaching the humidifier. Refer to the humidifier manual.   |

## Controls Buttons

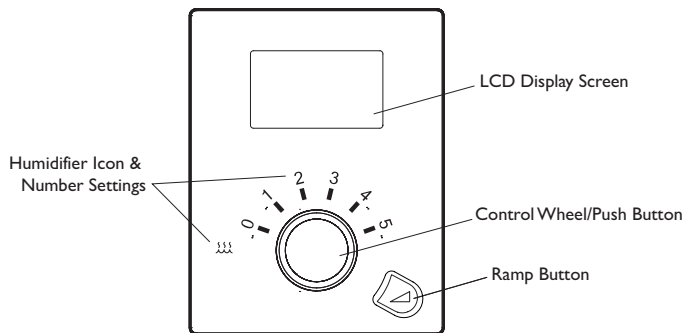

This figure shows the primary control buttons on the device, described in the following table.

| FEATURE                    | DESCRIPTION   |
|----------------------------|---|
| Display Screen             | Shows therapy settings, patient data, and other messages. The startup screen is shown temporarily when the unit is first powered.   |
| Humidifier Icon            | This Icon lights up when the optional humidifier is attached. The humidifier number settings are only visible when the humidifier is attached and therapy is active. Please refer to the humidifier user manual for more information. |
| Control Wheel/ Push Button | Turn the wheel to toggle between options on the screen. Press the wheel to choose an option. Primary function is to turn airflow on/off.  |
| Ramp Button                | When the airflow is on, this button allows you to activate or restart the ramp function. This button lights up when therapy is active or during specific alerts.  |

## Available Therapies

The REMstar Pro C-Flex+ device delivers the following therapies:

- **CPAP** – Delivers Continuous Positive Airway Pressure; CPAP maintains a constant level of pressure throughout the breathing cycle. If your health care professional prescribed ramp for you, press the Ramp button to reduce the pressure and then gradually increase the pressure to the therapeutic pressure setting so that you can fall asleep more comfortably.
- **CPAP with C-Flex** – Delivers CPAP therapy with pressure relief upon exhalation to improve patient comfort based on patient needs.
- **CPAP with C-Flex+** – Delivers CPAP therapy with pressure relief taking place at the end of inhalation and at the start of exhalation to improve patient comfort based on patient needs.

## Installing the Air Filters

**CAUTION:** A properly installed, undamaged gray foam filter is required for proper operation.

The device uses a gray foam filter that is washable and reusable, and an optional white ultra-fine filter that is disposable. The reusable filter screens out normal household dust and pollens, while the optional ultra-fine filter provides more complete filtration of very fine particles. The gray reusable filter must be in place at all times when the device is operating. The ultra-fine filter is recommended for people who are sensitive to tobacco smoke or other small particles.

A reusable gray foam filter is supplied with the device. A disposable ultra-fine filter is available as an accessory. If your filter is not already installed when you receive your device, you must at least install the reusable gray foam filter before using the device. To install the filter(s):

1. If you are using the white disposable ultra-fine filter, insert it into the filter area first, mesh-side facing in, towards the device.
2. Insert the required gray foam filter into the filter area after the ultra-fine filter.

**Note:** If you are not using the white disposable filter, simply insert the gray foam filter into the filter area.

## Connecting the Breathing Circuit

To use the system, you will need the following accessories in order to assemble the recommended circuit:

- Respironics interface (nasal mask or full face mask) with integrated exhalation port, or Respironics interface with a separate exhalation device (such as the Whisper Swivel II)
- Respironics 1.83 m (6 ft.) flexible tubing
- Respironics headgear (for the mask)

**WARNING:** If the device is used by multiple persons (such as rental devices), a low-resistance, main flow bacteria filter should be installed in-line between the device and the circuit tubing to prevent contamination.

To connect your breathing circuit to the device, complete the following steps:

1. Connect the flexible tubing to the air outlet on the side of the device.

**Note:** If required, connect a bacteria filter to the device air outlet, and then connect the flexible tubing to the outlet of the bacteria filter.

**Note:** The bacteria filter is recommended to protect the patient, care provider and equipment from the transference of a virus or bacteria through the breathing circuit.

**Note:** When using the bacteria filter, the device performance may be affected. However, the device will remain functional and deliver therapy.

2. Connect the tubing to the mask. Refer to the instructions that came with your mask.
3. Attach the headgear to the mask if necessary. Refer to the instructions that came with your headgear.

## Where to Place the Device

Place the device on a firm, flat surface somewhere within easy reach of where you will use it at a level lower than your sleeping position. Make sure the filter area on the back of the device is not blocked by bedding, curtains, or other items. Air must flow freely around the device for the system to work properly. Make sure the device is away from any heating or cooling equipment (e.g., forced air vents, radiators, air conditioners).

**CAUTION:** Do not place the device directly onto carpet, fabric, or other flammable materials.

**CAUTION:** Do not place the device in or on any container that can collect or hold water.

## Supplying AC Power to the Device

**CAUTION:** Condensation may damage the device. If this device has been exposed to either very hot or very cold temperatures, allow it to adjust to room temperature (operating temperature) before starting therapy. Do not operate the device outside of the operating temperature range shown in the Specifications.

**WARNING:** Be sure to route the power cord to the outlet in a way that will prevent the cord from being tripped over or interfered with by chairs or other furniture.

**WARNING:** This device is activated when the power cord is connected.

**IMPORTANT:** If you are using your device with a humidifier, refer to the instructions included with your humidifier for details on how to power the device and humidifier.

Complete the following steps to operate the device using AC power:

1. Plug the socket end of the AC power cord (included) into the power supply (also included).
2. Plug the pronged end of the AC power cord into an electrical outlet that is not controlled by a wall switch.
3. Plug the power supply cord's connector into the power inlet on the back of the device.
4. Ensure that all connections are secure.

**IMPORTANT:** To remove AC power, disconnect the power supply cord from the electrical outlet.

**WARNING:** Periodically inspect electrical cords and cables for damage or signs of wear. Discontinue use and replace if damaged.

**CAUTION:** Do not use extension cords with this device.

## Navigating the Device Screens

Turn the Wheel to toggle between options and settings on the screen. Press the Wheel to choose an option or setting that is highlighted. If you choose "Back" on any screen, it will take you back to the previous screen.

**Note:** The screens shown throughout this manual are examples only. Actual screens may vary slightly. Examples are for reference only.

## Starting the Device

1. Supply power to the device.
2. The Home screen will appear, shown below.

|         |       |
|---------|-------|
| Therapy | Flex  |
| Info    | Setup |

### Home Screen

**Note:** "Flex" shown above will display as the current Flex setting chosen by the provider.

3. Put on your mask assembly.

**Note:** If you are having trouble with your mask, refer to the instructions supplied with the mask.

4. Turn the Wheel to toggle between the four options. Highlight "Therapy". Press the Wheel to turn on the airflow and begin therapy. The Therapy screen will appear which will show the current pressure setting being delivered.
5. Make sure that no air is leaking from your mask into your eyes. If necessary, adjust the mask and headgear until the air leak stops. See the instructions provided with your mask for more information.

**Note:** A small amount of mask leak is normal and acceptable. Correct large mask leaks or eye irritation from an air leak as soon as possible.

6. If you are using the device in a bed with a headboard, try placing the tubing over the headboard. This may reduce tension on the mask.
7. Press the Wheel again to turn off therapy and return to the Home screen.

## Ramp Feature

The device is equipped with an optional ramp feature that your home care provider can enable or disable. This feature reduces the air pressure when you are trying to fall asleep and then gradually increases (ramps) the pressure until your prescription setting is reached, allowing you to fall asleep more comfortably.

If ramp is enabled on your device, after you turn on the airflow, press the RAMP button on the top of the device. You can use the RAMP button as often as you wish during the night.

**Note:** If the ramp feature is disabled, nothing will happen when you press the RAMP button.

## Flex Screen

From the Home screen, highlight the “Flex” option and press the wheel. The following Flex screen will appear.

|      |           |   |   |   |
|------|-----------|---|---|---|
| Flex | Back      |   |   |   |
|      | Flex      | 1 | 2 | 3 |
|      | Flex demo | 1 | 2 | 3 |

Flex Screen

**Note:** “Flex” shown above will display as the current Flex setting chosen by the provider.

- **Flex** - The Flex comfort feature allows you to adjust the level of air pressure relief that you feel when you exhale during therapy. Your home care provider can enable, lock or disable this feature. When your provider enables Flex, a level will already be set for you on the device. If this is not comfortable, you can increase or decrease the setting. The setting of “1” provides a small amount of pressure relief, with higher numbers providing additional relief. If the provider has disabled this feature, the flex screen will display “Flex is disabled”. If the provider has locked this feature, a lock symbol will display next to the setting.
- **Flex demo** - The Flex setting allows you to set the Flex level prior to beginning therapy. The Flex demo setting allows you to try out the different Flex settings in real time. After a period of time of inactivity, the device will stop therapy and will use the last Flex demo setting as the new Flex setting for your device. When therapy is again started from the Home screen, the device will operate using the new Flex setting.

## Setup Screen



From the Home screen, highlight the “Setup” option and press the wheel. The following Setup screen will appear. The user can change settings in the Setup menu.

|       |                       |                   |    |    |    |    |   |
|-------|-----------------------|-------------------|----|----|----|----|---|
| Setup | Back                  |                   |    |    |    |    |   |
|       | Flex                  | 1                 | 2  | 3  |    |    |   |
|       | Humidifier            | 0                 | 1  | 2  | 3  | 4  | 5 |
|       | Ramp start            | 4.0 - (CPAP pres) |    |    |    |    |   |
|       | SYSTEM ONE resistance | X1                | X2 | X3 | X4 | X5 |   |
|       | Auto on               | on off            |    |    |    |    |   |
|       | Auto off              | on off            |    |    |    |    |   |
|       | Mask alert            | on off            |    |    |    |    |   |
|       | LED backlight         | on off            |    |    |    |    |   |
|       | Back                  |                   |    |    |    |    |   |

Setup Screen

**Note:** The screen will only show 4 lines at a time. As you rotate the Wheel to toggle over different options the screen will slide up and down accordingly.

**Note:** If the text is too long to completely fit on the screen, it will scroll horizontally across the screen when highlighted.

- **Flex** - This displays the Flex level set by your home care provider. “Flex” will display as the current Flex setting chosen by the provider. Your home care provider will either enable, lock, or disable Flex. If Flex is enabled and the setting is not comfortable, you can increase or decrease this setting. If your provider has locked a Flex setting into place, you can view the setting but cannot change it, and the screen will display a lock symbol. If your provider has disabled Flex, you will not see this setting.
- **Humidifier** - This displays the humidifier setting. This will only display if the humidifier is attached. Please refer to the humidifier manual if using a humidifier.
- **Ramp Start** - This displays the ramp starting pressure. You can increase or decrease the ramp starting pressure in 0.5 cm H<sub>2</sub>O increments. This is only available if Ramp time has been set to >0 and CPAP pressure >4 cm H<sub>2</sub>O.
- **SYSTEM ONE resistance** (  ← ) - This setting allows you to adjust the level of air pressure relief based on the specific Respironics mask. Each Respironics mask may have a “System One” resistance control setting which will appear next to the symbol (ex.  ← X3). Contact your home care provider if you cannot find this resistance setting for your mask. If your provider has locked the resistance setting into place, you can view the setting but cannot change it, and the screen will display a lock symbol. If your provider has disabled resistance, you will not see this setting.
- **Auto on** - You can enable this feature if you want the device to automatically turn the airflow on whenever you apply the interface (mask) to your airway.
- **Auto off** - You can enable this feature if you want the device to automatically turn the airflow off whenever you remove the interface (mask) from your airway.
- **Mask alert** - You can enable or disable the mask alert setting. If this feature is enabled, the mask alert will appear on the display screen when a significant mask leak is detected, and an audible alert will sound. Refer to the Device Alerts section for more information about the mask alert.
- **LED backlight** - You can enable or disable the LED backlight for the humidifier icon and settings on the device.

## Info Screen

From the Home screen, highlight the “Info” option and press the wheel. The following Info screen will appear. The user cannot change settings in the Info menu.

**Note:** These screens are only for reference. Your home care provider may periodically ask you for this information.

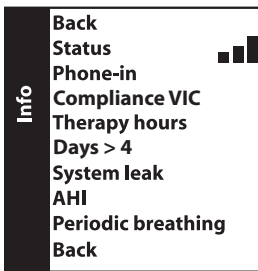

### Info Screen

**Note:** The screen will only show 4 lines at a time. As you rotate the Wheel to toggle over different options the screen will slide up and down accordingly.

- **Status** - This displays information sent from a peripheral (SD card, modem, etc.). If two peripherals are attached, two lines will appear with corresponding icons.

- **Phone-in** - This screen displays the total therapy hours for the device, the total blower hours, and the total number of days used when the sessions were greater than 4 hours since the device was last reset by the home care provider. This screen also displays a compliance number used by your home care provider to validate that the data provided by you is the data taken from this screen. This setting only appears if your provider has enabled this feature.
- **Compliance VIC (Visual Inspection Check)** - This screen displays the start date and the total number of days used when the sessions were greater than 4 hours. This screen also displays a check code number used by your home care provider to validate that the data provided by you is the data taken from this screen. This setting only appears if your provider has enabled this feature.
- **Therapy hours** - The device is capable of recognizing the difference between the time the patient is actually receiving therapy and the time when the blower is simply running. This screen displays the average amount of time the patient is actually receiving therapy on the device over a 7 day and 30 day time frame (provided the device has at least 7 or 30 days of data respectively). If the device has only 5 days of data to use for the calculation, the 5 day average value will be seen under the 7 day display.
- **Days > 4** - This screen displays the cumulative number of device therapy sessions that exceeded 4 hours over a 7 day and 30 day time frame.
- **System leak** - During any given night, the device recognizes the percentage of time the patient was experiencing what it deemed to be a large leak. Large leak is defined as the level of leak that is so large, it is no longer possible to determine respiratory events with statistical accuracy. This screen displays the average of these individual nightly values of percentage of time in large leak over a 7 day and 30 day time frame (provided the device has at least 7 or 30 days of data respectively). If the device has only 5 days of data to use for the calculation, the 5 day average value will be seen under the 7 day display. If you see a large increase in the percent of time in large leak indicated here, contact your home care provider for assistance. This screen only displays if your home care provider has enabled it.
- **AHI** - The device accumulates individual Apnea/Hypopnea indices (AHI) for each session the patient used the device. This screen displays the average of these individual nightly AHI values over a 7 day and 30 day time frame (provided the device has at least 7 or 30 days of data respectively). If the device has only 5 days of data to use for the calculation, the 5 day average value will be seen under the 7 day display.
- **Periodic Breathing** - During any given night, the device recognizes the percentage of time the patient was experiencing periodic breathing. This screen displays the average of these individual nightly values of periodic breathing over a 7 day and 30 day time frame (provided the device has at least 7 or 30 days of data respectively). If the device has only 5 days of data to use for the calculation, the 5 day average value will be seen under the 7 day display. If you see a large increase in the percent of time in periodic breathing indicated here, contact your home care provider for assistance. This screen only displays if your home care provider has enabled it.

## Device Alerts

- **High Priority:** These alerts require immediate operator response. The alert signal consists of a high priority sound, which is a continuous two-beep pattern (indicated in the following table as: • • • •). Additionally, the backlights on the buttons will provide a high priority flashing pattern consisting of a continuous, bright-to-off, two-flash pattern (indicated in the following table as: ◇ ◇ ◇).
- **Medium Priority:** These alerts require prompt operator response. The alert signal consists of a medium priority sound, which is a continuous one-beep pattern (indicated in the following table as: • • •). Additionally, the backlights on the buttons will provide a medium priority flashing pattern consisting of a continuous, bright-to-dim, one-flash pattern (indicated in the following table as: ◇ ◇).

**Alert Summary Table:** The following table summarizes the alerts.

| ALERT            | AUDIBLE INDICATOR | VISUAL INDICATOR  | DEVICE ACTION   | POSSIBLE CAUSE  | PATIENT ACTION  |
|------------------|-------------------|---|---|---|---|
| Service Required | • • • •           | ◇ ◇ ◇<br>Screen displays "Service required", indicating that service is required.   | The device enters the "Safe state" in which the device power remains on, but the airflow is disabled.   | Device failure.   | Press either the wheel or ramp button to silence the alert. Remove the power supply cord from the device to remove power. Plug the cord back into the device's power inlet to restore power. If the alert continues to occur, contact your home care provider.  |
| Mask Alert       | • • •             | ◇ ◇<br>Screen displays "Mask alert".  | Alert present until action is taken.  | The breathing circuit is disconnected or there is a large air leak. | Turn off airflow. Check your breathing circuit connections and reconnect the tubing if it has come loose. Make sure your mask is on properly before you restart the airflow. If the alert continues to occur, contact your home care provider to have your mask checked. You may need a mask refitting. |
| Auto Off         | single beep       | Screen displays "Auto off".   | The airflow shuts off and the device enters the Standby state approximately 45-60 seconds after detection. Alert present for 30 seconds or until user acknowledges. | The mask has been removed.  | Put your mask back on and turn the airflow on to resume therapy.  |
| Humidifier Alert | none              | ◇ ◇<br>Humidifier LED icon will flash.<br> | Only displayed when both the humidifier and therapy is on.  | Humidifier failure.   | Alert is present for 10 minutes or until the condition is fixed. Turn off airflow and reconnect the humidifier to the device according to the humidifier instructions. If the alert continues to occur, contact your home care provider.  |

| ALERT                          | AUDIBLE INDICATOR | VISUAL INDICATOR  | DEVICE ACTION   | POSSIBLE CAUSE                     | PATIENT ACTION  |
|--------------------------------|-------------------|---|---|------------------------------------|---|
| Patient Reminder               | single beep       | Screen displays message from the provider.                        | Only displayed when therapy transitions from on to off. Alert present for 6 minutes or until user acknowledges. | Message from the provider.         | Your home care provider may set a patient reminder scheduled to pop up at a particular time to remind you to replace your mask, change your filters, etc. "Check your mask, a new one may be available. Call your provider:" is the default message. The provider may change the message. |
| Instant Message                | single beep       | Home care provider will supply text to be displayed.              | Only displayed when therapy is off.   | Message from the provider.         | Your home care provider may send an instant message. Contact your home care provider with any questions.  |
| SD Card: Prescription Accepted | single beep       | Screen displays "SD card inserted, prescription accepted".        | Alert present for 30 seconds or until user acknowledges.  | n/a                                | Card status can be checked in Status menu.  |
| SD Card: Prescription Rejected | single beep       | ◇ ◇<br>Screen displays "SD card inserted, prescription rejected". | Alert present for 30 seconds or until user acknowledges.  | Prescription missing or incorrect. | Contact your home care provider for correct prescription.   |
| SD Card: Inserted Incorrectly  | • •               | ◇ ◇<br>Screen displays "SD card inserted incorrectly".            | Alert present until action is taken.  | SD card inserted incorrectly.      | Alert is present until card is removed. Remove SD card and reinsert correctly. If the alert continues to occur, contact your home care provider.  |
| SD Card: Full                  | • •               | ◇ ◇<br>Screen displays "SD card full".                            | Alert present until action is taken.  | SD card is full.                   | Alert is present until card is removed. Card status can be checked in the Status menu. Remove SD card and replace.  |
| SD Card: Remove                | single beep       | ◇ ◇<br>Screen displays "SD card removed".                         | Alert present for 30 seconds or until user acknowledges.  | SD card has been removed.          | No action needed.   |
| SD Card: Data Activity         | single beep       | Screen displays "Data activity: Do not remove card".              | Alert present until user acknowledges or data activity complete.  | n/a                                | Only displayed immediately after therapy is turned off when data is transferring to the card.   |

| ALERT                        | AUDIBLE INDICATOR | VISUAL INDICATOR   | DEVICE ACTION  | POSSIBLE CAUSE  | PATIENT ACTION  |
|------------------------------|-------------------|--|--|---|---|
| SD Card: Corrupt             | • •               | ◇ ◇<br>Screen displays "Corrupt card inserted reformat card?".                           | Alert present until action is taken.   | A problem exists with the SD card. The data may be corrupted.                                       | Choose "yes" to reformat the card. Screen displays "Reformatting... do not remove card".<br><br>If you choose no, the alert will disappear and the card will not be reformatted. Note: Any information on the card will be lost when reformatted. Contact your home care provider with any questions. |
| SD Card: Write Protected     | • •               | ◇ ◇<br>Screen displays "SD card write protected!".                                       | Alert present until action is taken.   | SD card is read only.   | SD card is read only. You cannot save information to this card. Replace with another card that isn't write protected to store information. Contact your home care provider with any questions.  |
| SD Card: Remove and Reinsert | • •               | ◇ ◇<br>Screen displays "SD card error: remove and reinsert".                             | Alert present until action is taken.   | Device cannot read the SD card. A problem may exist with the SD card or it is inserted incorrectly. | Remove SD card and reinsert. If the alert continues to occur, replace with another card or contact your home care provider.   |
| Modem: Making Call           | single beep       | Modem will display its own icon on the device. Refer to modem instruction manual.        | Alert present for 30 seconds after call sequence or until user acknowledges. | Refer to modem instruction manual.  | If modem is making call while therapy is active, alert for call sequence is not displayed.  |
| Modem: Unsuccessful Call     | single beep       | ◇ ◇<br>Modem will display its own icon on the device. Refer to modem instruction manual. | Alert present for 30 seconds or until user acknowledges.                     | Refer to modem instruction manual.  | No action needed.   |

## Troubleshooting

The table below lists some of the problems you may experience with your device and possible solutions to those problems.

| PROBLEM   | WHY IT HAPPENED  | WHAT TO DO  |
|---|--|---|
| Nothing happens when you apply power to the device. The backlights on the buttons do not light. | There's no power at the outlet or the device is unplugged.   | <p>If you are using AC power, check the outlet and verify that the device is properly plugged in. Make sure there is power available at the outlet. Make sure the AC power cord is connected correctly to the power supply and the power supply cord is securely connected to the device's power inlet. If the problem continues to occur, contact your home care provider. Return both the device and power supply to your provider, so they can determine if the problem is with the device or power supply.</p> <p>If you are using DC power, make sure your DC power cord and battery adaptor cable connections are secure. Check your battery. It may need recharged or replaced. If the problem persists, check the DC cord's fuse following the instructions supplied with your DC cord. The fuse may need to be replaced. If the problem still occurs, contact your home care provider.</p> |
| The airflow does not turn on.   | There may be a problem with the blower.  | Make sure the device is powered correctly. Make sure "Therapy" is highlighted when pressing the control wheel to start airflow. If the airflow does not turn on, there may be a problem with your device. Contact your home care provider for assistance.   |
| The device's display is erratic.  | The device has been dropped or mishandled, or the device is in an area with high Electromagnetic Interference (EMI) emissions. | Unplug the device. Reapply power to the device. If the problem continues, relocate the device to an area with lower EMI emissions (away from electronic equipment such as cellular phones, cordless phones, computers, TVs, electronic games, hair dryers, etc.). If the problem still occurs, contact your home care provider for assistance.  |
| The Ramp feature does not work when you press the Ramp button.                                  | Your home care provider did not prescribe Ramp for you, or your CPAP pressure is already set to the minimum setting.           | <p>If Ramp has not been prescribed for you, discuss this feature with your home care provider to see if they will change your prescription.</p> <p>If your provider has enabled Ramp, but the feature still does not work, check the CPAP setting on your Active Display screen. If CPAP is set to the minimum setting (4.0 cm H<sub>2</sub>O), or the starting pressure is the same as the prescribed pressure, the Ramp feature will not work. Make sure that the ramp time setting is &gt;0.</p>   |
| The airflow is much warmer than usual.  | <p>The air filters may be dirty.</p> <p>The device may be operating in direct sunlight or near a heater.</p>                   | <p>Clean or replace the air filters.</p> <p>The temperature of the air may vary somewhat based on your room temperature. Make sure that the device is properly ventilated. Keep the device away from bedding or curtains that could block the flow of air around the device. Make sure the device is away from direct sunlight and heating equipment.</p> <p>If using the humidifier with the device, check the humidifier settings. Refer to the humidifier instructions to make sure the humidifier is working properly.</p> <p>If the problem continues, contact your home care provider.</p>  |

## Accessories

There are several accessories available for your REMstar Pro C-Flex+ system such as a humidifier or a modem. Contact your home care provider for additional information on the available accessories. When using optional accessories, always follow the instructions enclosed with the accessories.

### Adding a Humidifier

You can use the Heated humidifier or the Passover humidifier with your device. They are available from your home care provider. A humidifier may reduce nasal dryness and irritation by adding moisture to the airflow.

**CAUTION:** For safe operation, the humidifier must always be positioned below the breathing circuit connection at the mask and the air outlet on the device. The humidifier must be level for proper operation.

**Note:** Refer to the humidifier's instructions for complete setup information.

### Using the SD Card

The REMstar Pro C-Flex+ system comes with an SD card inserted in the SD card slot on the back of the device to record information for the home care provider. Your home care provider may ask you to periodically remove the SD card and send it to them for evaluation.

**Note:** The SD card does not need to be installed for the device to work properly. The SD card records device usage information for your home care provider. You can refer to the Device Alerts section in this manual for more information on the SD card. Contact your provider if you have any questions about the SD card.

### Adding Supplemental Oxygen

Oxygen may be added at the mask connection. Please note the warnings listed below when using oxygen with the device.

#### **WARNINGS:**

- When using oxygen with this system, the oxygen supply must comply with local regulations for medical oxygen.
- When using oxygen with this system, a Respiration Pressure Valve must be placed in-line with the patient circuit after the oxygen source. Failure to use the pressure valve could result in a fire hazard.
- When using oxygen with this system, turn the device on before turning on the oxygen. Turn the oxygen off before turning the device off. This will prevent oxygen accumulation in the device.
- Do not connect the device to an unregulated or high pressure oxygen source.

### Supplying DC Power to the Device

The Respiration DC Power Cord can be used to operate this device in a stationary recreational vehicle, boat, or motor home. The Respiration DC Battery Adapter Cable, when used with the DC Power Cord, enables the device to be operated from a 12 VDC free-standing battery.

**CAUTION:** When DC power is obtained from a vehicle battery, the device should not be used while the vehicle's engine is running. Damage to the device may occur.

**CAUTION:** Only use a Respiration DC Power Cord and Battery Adapter Cable. Use of any other system may cause damage to the device.

Refer to the instructions supplied with the DC Power Cord and adapter cable for information on how to operate the device using DC power.

## Traveling with the System

When traveling, the carrying case is for carry-on luggage only. The carrying case will not protect the system if it is put through checked baggage.

For your convenience at security stations, there is a note on the bottom of the device stating that it is medical equipment. It may be helpful to bring this manual along with you to help security personnel understand the REMstar Pro C-Flex+ device.

If you are traveling to a country with a line voltage different than the one you are currently using, a different power cord or an international plug adaptor may be required to make your power cord compatible with the power outlets of the country to which you are traveling. Contact your home care provider for additional information.

## Cleaning the Device

**WARNING:** To avoid electrical shock, always unplug the power cord from the wall outlet before cleaning the device. DO NOT immerse the device in any fluids.

1. Unplug the device, and wipe the outside of the device with a cloth slightly dampened with water and a mild detergent. Let the device dry completely before plugging in the power cord.
2. Inspect the device and all circuit parts for damage after cleaning. Replace any damaged parts.

## Cleaning or Replacing the Filters

Under normal usage, you should clean the gray foam filter at least once every two weeks and replace it with a new one every six months. The white ultra-fine filter is disposable and should be replaced after 30 nights of use or sooner if it appears dirty. DO NOT clean the ultra-fine filter.

**CAUTION:** Dirty inlet filters may cause high operating temperatures that may affect device performance.

Regularly examine the inlet filters as needed for integrity and cleanliness.

1. If the device is operating, stop the airflow. Disconnect the device from the power source.
2. Remove the filter(s) from the enclosure by gently squeezing the filter in the center and pulling it away from the device.
3. Examine the filter(s) for cleanliness and integrity.
4. Wash the gray foam filter in warm water with a mild detergent. Rinse thoroughly to remove all detergent residue. Allow the filter to air dry completely before reinstalling it. If the foam filter is torn, replace it. (Only Respironics-supplied filters should be used as replacement filters.)
5. If the white ultra-fine filter is dirty or torn, replace it.
6. Reinstall the filters, inserting the white ultra-fine filter first if applicable.

**CAUTION:** Never install a wet filter into the device. You must ensure sufficient drying time for the cleaned filter.

## Cleaning the Tubing

Clean the tubing daily. Disconnect the flexible tubing from the device. Gently wash the tubing in a solution of warm water and a mild detergent. Rinse thoroughly. Air dry.

## Service

The device does not require routine servicing.

**WARNING:** If you notice any unexplained changes in the performance of this device, if it is making unusual or harsh sounds, if it has been dropped or mishandled, if water is spilled into the enclosure, or if the enclosure is broken, disconnect the power cord and discontinue use. Contact your home care provider.

# Specifications

## Environmental

Operating Temperature: 5° to 35° C (41° to 95° F)  
Storage Temperature: -20° to 60° C (-4° F to 140° F)  
Relative Humidity (operating & storage): 15 to 95% (non-condensing)  
Atmospheric Pressure: 101 to 77 kPa (0 - 2286 m / 0 - 7500 ft)

## Physical

Dimensions: 18 x 14 x 10 cm (7" L x 5.5" W x 4" H)  
Weight (Device with power supply): Approximately 1.53 kg (3.37 lbs)

## Standards Compliance

This device is designed to conform to the following standards:

IEC 60601-1 General Requirements for Safety of Medical Electrical Equipment  
EN ISO 17510-1 Sleep Apnea Breathing Therapy Devices  
EN 60601-1-2 Electromagnetic Compatibility

## IEC 60601-1 Classification

Type of Protection Against Electric Shock: Class II Equipment  
Degree of Protection Against Electric Shock: Type BF Applied Part  
Degree of Protection against Ingress of Water (device & AC power supply): Drip Proof, IPX1  
Mode of Operation: Continuous

## Electrical

AC Power Consumption: 100 – 240 VAC, 50/60 Hz, 2.1 A  
DC Power Consumption: 12VDC, 5.0 A  
Fuses: There are no user-replaceable fuses.

## Pressure Accuracy

Pressure Increments: 4.0 to 20.0 cm H<sub>2</sub>O (in 0.5 cm H<sub>2</sub>O increments)  
Pressure Stability:

|                      | Static                    | Dynamic<br>< 10 cm H <sub>2</sub> O | Dynamic<br>≥ 10.0 to 20 cm H <sub>2</sub> O |
|----------------------|---------------------------|-------------------------------------|---|
| Device               | ± 0.5 cm H <sub>2</sub> O | ≤ 0.5 cm H <sub>2</sub> O           | ≤ 1.0 cm H <sub>2</sub> O                   |
| Device w/ Humidifier | ± 0.5 cm H <sub>2</sub> O | ≤ 0.5 cm H <sub>2</sub> O           | ≤ 1.0 cm H <sub>2</sub> O                   |

## Maximum Flow Rate

|  | Test pressures (cm H <sub>2</sub> O) |       |        |        |        |
|--|--------------------------------------|-------|--------|--------|--------|
|  | 4.0                                  | 8.0   | 12.0   | 16.0   | 20.0   |
| Measured pressure at the patient connection port (hPa) | 3.67                                 | 7.43  | 11.34  | 15.00  | 18.98  |
| Average flow at the patient connection port (l/min)    | 60.65                                | 95.27 | 123.93 | 131.00 | 114.17 |

## Noise

Sound Pressure Level: < 30 dB(A)  
This measurement applies to the therapy device with or without the optional Humidifier.  
Sound Power Level: < 38 dB(A)

## **Disposal**

Separate collection for electrical and electronic equipment per EC Directive 2002/96/EC. Dispose of this device in accordance with local regulations.

## **How to Contact Respironics**

To have your device serviced, contact your home care provider. If you need to contact Respironics directly, call the Customer Service department at 1-800-345-6443 or 1-724-387-4000.

You can also use the following address:

Respironics Inc.  
1001 Murry Ridge Lane  
Murrysville, PA 15668

## EMC Information

Guidance and Manufacturer's Declaration - Electromagnetic Emissions – This device is intended for use in the electromagnetic environment specified below. The user of this device should make sure it is used in such an environment.

| EMISSIONS TEST  | COMPLIANCE | ELECTROMAGNETIC ENVIRONMENT - GUIDANCE  |
|---|------------|---|
| RF emissions<br>CISPR 11                                | Group 1    | The device uses RF energy only for its internal function. Therefore, its RF emissions are very low and are not likely to cause any interference in nearby electronic equipment. |
| RF emissions<br>CISPR 11                                | Class B    | The device is suitable for use in all establishments, including domestic establishments and those directly connected to the public low-voltage power supply network.            |
| Harmonic emissions<br>IEC 61000-3-2                     | Class A    |   |
| Voltage fluctuations/Flicker emissions<br>IEC 61000-3-3 | Complies   |   |

Guidance and Manufacturer's Declaration - Electromagnetic Immunity – This device is intended for use in the electromagnetic environment specified below. The user of this device should make sure it is used in such an environment.

| IMMUNITY TEST  | IEC 60601 TEST LEVEL  | COMPLIANCE LEVEL  | ELECTROMAGNETIC ENVIRONMENT - GUIDANCE   |
|--|---|---|--|
| Electrostatic Discharge (ESD)<br>IEC 61000-4-2   | ±6 kV contact<br>±8 kV air  | ±6 kV contact<br>±8 kV air  | Floors should be wood, concrete or ceramic tile. If floors are covered with synthetic material, the relative humidity should be at least 30%.  |
| Electrical fast Transient/burst<br>IEC 61000-4-4   | ±2 kV for power supply lines<br>±1 kV for input-output lines  | ±2 kV for supply mains<br>±1 kV for input/output lines  | Mains power quality should be that of a typical home or hospital environment.  |
| Surge<br>IEC 61000-4-5   | ±1 kV differential mode<br>±2 kV common mode  | ±1 kV differential mode<br>±2 kV for common mode  | Mains power quality should be that of a typical home or hospital environment.  |
| Voltage dips, short interruptions and voltage variations on power supply input lines<br>IEC 61000-4-11 | <5% $U_T$<br>(>95% dip in $U_T$ ) for 0.5 cycle<br>40% $U_T$<br>(60% dip in $U_T$ ) for 5 cycles<br>70% $U_T$ (30% dip in $U_T$ ) for 25 cycles<br><5% $U_T$ (>95% dip in $U_T$ ) for 5 sec | <5% $U_T$<br>(>95% dip in $U_T$ ) for 0.5 cycle<br>40% $U_T$<br>(60% dip in $U_T$ ) for 5 cycles<br>70% $U_T$ (30% dip in $U_T$ ) for 25 cycles<br><5% $U_T$ (>95% dip in $U_T$ ) for 5 sec | Mains power quality should be that of a typical home or hospital environment. If the user of the device requires continued operation during power mains interruptions, it is recommended that the device be powered from an uninterruptible power supply or a battery. |
| Power frequency (50/60 Hz) magnetic field<br>IEC 61000-4-8   | 3 A/m   | 3 A/m   | Power frequency magnetic fields should be at levels characteristic of a typical location in a typical hospital or home environment.  |
| NOTE: $U_T$ is the a.c. mains voltage prior to application of the test level.                          |   |   |  |

Guidance and Manufacturer's Declaration - Electromagnetic Immunity – This device is intended for use in the electromagnetic environment specified below. The user of this device should make sure it is used in such an environment.

| IMMUNITY TEST                 | IEC 60601 TEST LEVEL        | COMPLIANCE LEVEL | ELECTROMAGNETIC ENVIRONMENT -GUIDANCE  |
|-------------------------------|-----------------------------|------------------|--|
| Conducted RF<br>IEC 61000-4-6 | 3 Vrms<br>150 kHz to 80 MHz | 3 Vrms           | <p>Portable and mobile RF communications equipment should be used no closer to any part of the device, including cables, than the recommended separation distance calculated from the equation applicable to the frequency of the transmitter.</p> <p>Recommended separation distance<br/> <math>d = 1.2 \sqrt{P}</math></p> <p><math>d = 1.2 \sqrt{P}</math>     80 MHz to 800 MHz<br/> <math>d = 2.3 \sqrt{P}</math>     800 MHz to 2.5 GHz</p> <p>where P is the maximum output power rating of the transmitter in watts (W) according to the transmitter manufacturer and d is the recommended separation distance in meters (m).</p> <p>Field strengths from fixed RF transmitters, as determined by an electromagnetic site survey<sup>a</sup>, should be less than the compliance level in each frequency range.<sup>b</sup></p> <p>Interference may occur in the vicinity of equipment marked with the following symbol: </p> |
| Radiated RF<br>IEC 61000-4-3  | 3 V/m<br>80 MHz to 2.5 GHz  | 3 V/m            |  |

- NOTE 1 At 80 MHz and 800 MHz, the higher frequency range applies.
- NOTE 2 These guidelines may not apply in all situations. Electromagnetic propagation is affected by absorption and reflection from structures, objects, and people.
- a Field strengths from fixed transmitters, such as base stations for radio (cellular/cordless) telephones and land mobile radios, amateur radio, AM and FM radio broadcast and TV broadcast cannot be predicted theoretically with accuracy. To assess the electromagnetic environment due to fixed RF transmitters, an electromagnetic site survey should be considered. If the measured field strength in the location in which the device is used exceeds the applicable RF compliance level above, the device should be observed to verify normal operation. If abnormal performance is observed, additional measures may be necessary, such as re-orienting or relocating the device.
  - b Over the frequency range 150 kHz to 80 MHz, the field strengths should be less than 3 V/m.

Recommended Separation Distances between Portable and Mobile RF Communications Equipment and This Device: The device is intended for use in an electromagnetic environment in which radiated RF disturbances are controlled. The customer or the user of this device can help prevent electromagnetic interference by maintaining a minimum distance between portable and mobile RF communications equipment (transmitters) and this device as recommended below, according to the maximum output power of the communications equipment.

| RATED MAXIMUM POWER<br>OUTPUT OF TRANSMITTER<br>W | SEPARATION DISTANCE ACCORDING TO FREQUENCY OF TRANSMITTER<br>M |   |  |
|---|--|---|--|
|   | 150 kHz TO 80 MHz<br>$d = 1.2 \sqrt{P}$                        | 80 MHz TO 800 MHz<br>$d = 1.2 \sqrt{P}$ | 800 MHz TO 2.5 GHz<br>$d = 2.3 \sqrt{P}$ |
| 0.01  | 0.12   | 0.12                                    | 0.23                                     |
| 0.1   | 0.38   | 0.38                                    | 0.73                                     |
| 1   | 1.2  | 1.2                                     | 2.3                                      |
| 10  | 3.8  | 3.8                                     | 7.3                                      |
| 100   | 12   | 12                                      | 23                                       |

For transmitters rated at a maximum output power not listed above, the recommended separation distance *d* in meters (m) can be estimated using the equation applicable to the frequency of the transmitter, where P is the maximum output power rating of the transmitter in watts (W) according to the transmitter manufacturer.

Note 1: At 80 MHz and 800 MHz, the separation distance for the higher frequency range applies.

Note 2: These guidelines may not apply in all situations. Electromagnetic propagation is affected by absorption and reflection from structures, objects, and people.

## Limited Warranty

Respironics, Inc. warrants that the system shall be free from defects of workmanship and materials and will perform in accordance with the product specifications for a period of two (2) years from the date of sale by Respironics, Inc. to the dealer. If the product fails to perform in accordance with the product specifications, Respironics, Inc. will repair or replace – at its option – the defective material or part. Respironics, Inc. will pay customary freight charges from Respironics, Inc. to the dealer location only. This warranty does not cover damage caused by accident, misuse, abuse, alteration, water ingress, and other defects not related to material or workmanship. The Respironics, Inc. Service department shall examine any devices returned for service, and Respironics, Inc. reserves the right to charge an evaluation fee for any returned device as to which no problem is found after investigation by Respironics, Inc. Service.

Respironics, Inc. disclaims all liability for economic loss, loss of profits, overhead, or consequential damages which may be claimed to arise from any sale or use of this product. Some states do not allow the exclusion or limitation of incidental or consequential damages, so the above limitation or exclusion may not apply to you.

This warranty is given in lieu of all other express warranties. In addition, any implied warranties – including any warranty of merchantability or fitness for the particular purpose – are limited to two years. Some states do not allow limitations on how long an implied warranty lasts, so the above limitation may not apply to you. This warranty gives you specific legal rights, and you may also have other rights which vary from state to state.

To exercise your rights under this warranty, contact your local authorized Respironics, Inc. dealer or contact Respironics, Inc. at:

1001 Murry Ridge Lane  
Murrysville, Pennsylvania 15668-8550  
1-724-387-4000

Manufactured for:

Respironics Inc.  
1001 Murry Ridge Lane  
Murrysville, PA 15668 USA

**REF** **1058278**

1057245  
JR 6/23/2009  
EN-DOM