

**Mirage Liberty™**





MASQUE FACIAL

**Components Guide**

Système complet

S\* 61300 L\* 61301

Entourage rigide (pas de harnais)

	 (S*)	 (M*)	 (L*)
 (S*)	<b>61318</b>	<b>61319</b>	<b>61320</b>
 (L*)	<b>61321</b>	<b>61322</b>	<b>61323</b>

Ensemble entourage rigide (sans bulle, coussins ni harnais)

S\* 61325 L\* 61326

Ensemble coude (coude, valve et clip)

61340

Français

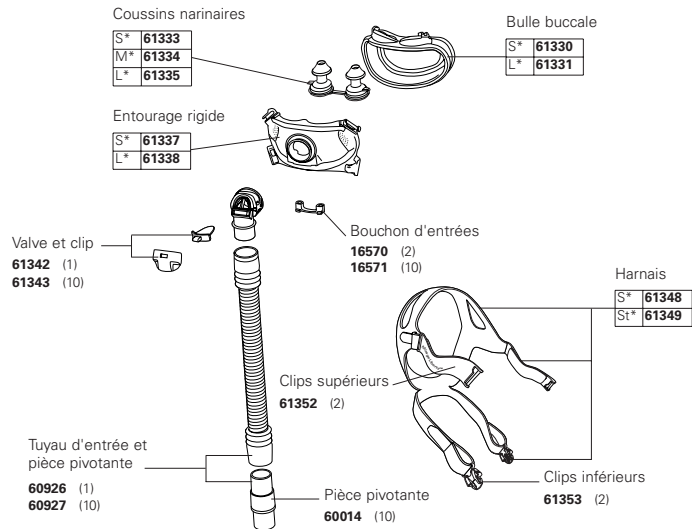

S\* Petit M\* Médium L\* Grande St\* Estándar

For details, refer to the *Mirage Liberty User Guide*. Specifications may change without notice. Mirage and Mirage Liberty are trademarks of ResMed Ltd and Mirage is registered in U.S. Patent and Trademark Office. © 2007 ResMed Ltd. 1011556/1 07 03

**Mirage Liberty™**





FULL FACE MASK

**Components Guide**

Complete system

S\* 61300 L\* 61301

Frame system (no headgear)

	 (S*)	 (M*)	 (L*)
 (S*)	<b>61318</b>	<b>61319</b>	<b>61320</b>
 (L*)	<b>61321</b>	<b>61322</b>	<b>61323</b>

Frame assembly (no headgear, cushion or pillows)

S\* 61325 L\* 61326

Elbow assembly (elbow, valve and clip)

61340

English

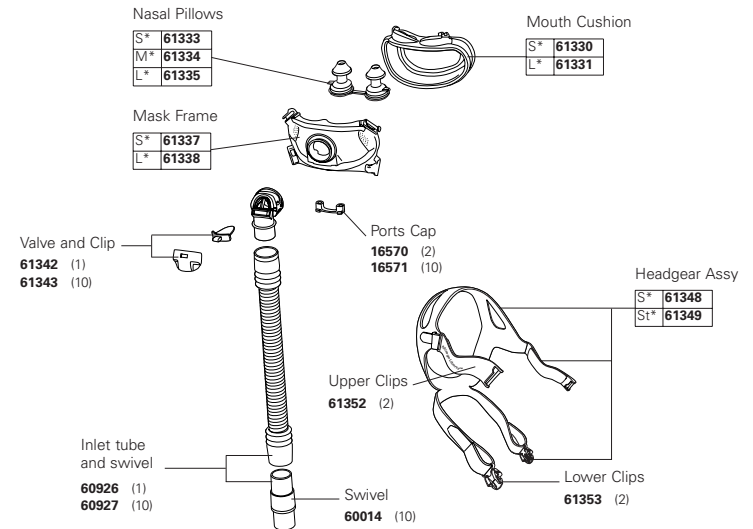

S\* Small M\* Medium L\* Large St\* Standard

For details, refer to the *Mirage Liberty User Guide*. Specifications may change without notice. Mirage and Mirage Liberty are trademarks of ResMed Ltd and Mirage is registered in U.S. Patent and Trademark Office. © 2007 ResMed Ltd. 1011556/1 07 03

## Mirage Liberty™





MASCARILLA FACIAL

### Components Guide

Sistema completo

S\* 61300 L\* 61301

Sistema de armazón (sin arnés para la cabeza)

	 (S*)	 (M*)	 (L*)
 (S*)	<b>61318</b>	<b>61319</b>	<b>61320</b>
 (L*)	<b>61321</b>	<b>61322</b>	<b>61323</b>

Armazón (con exclusión de la almohadilla bucal, las almohadillas nasales y el arnés para la cabeza)

S\* 61325 L\* 61326

Unidad del codo (codo, válvula y traba)  
61340

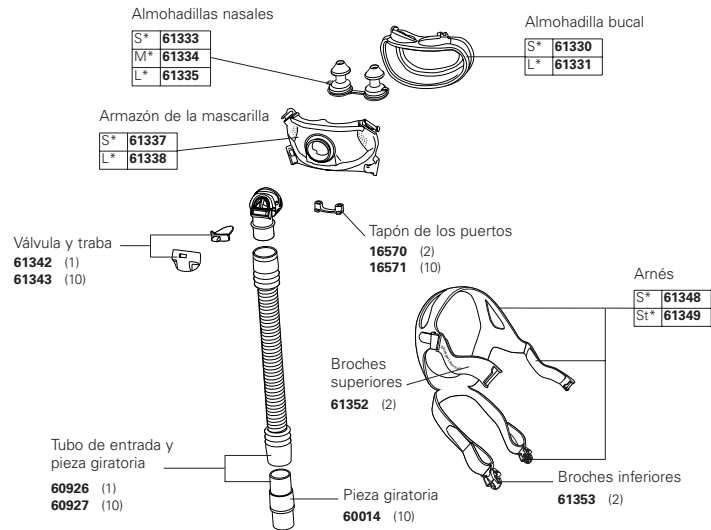

S\* Pequeña M\* Mediana L\* Grande St\* Estándar

For details, refer to the *Mirage Liberty User Guide*. Specifications may change without notice. Mirage and Mirage Liberty are trademarks of ResMed Ltd and Mirage is registered in U.S. Patent and Trademark Office. © 2007 ResMed Ltd. 1011556/1 07 03

## Mirage Liberty™





MÁSCARA FACIAL

### Components Guide

Sistema completo

S\* 61300 L\* 61301

Armação de Máscara (sem arnés)

	 (S*)	 (M*)	 (L*)
 (S*)	<b>61318</b>	<b>61319</b>	<b>61320</b>
 (L*)	<b>61321</b>	<b>61322</b>	<b>61323</b>

Sistema de armação (excluyendo almohada bucal, estofos nasais e arnés)

S\* 61325 L\* 61326

Conjunto do cotovelo (cotovelo, válvula e presilha)  
61340

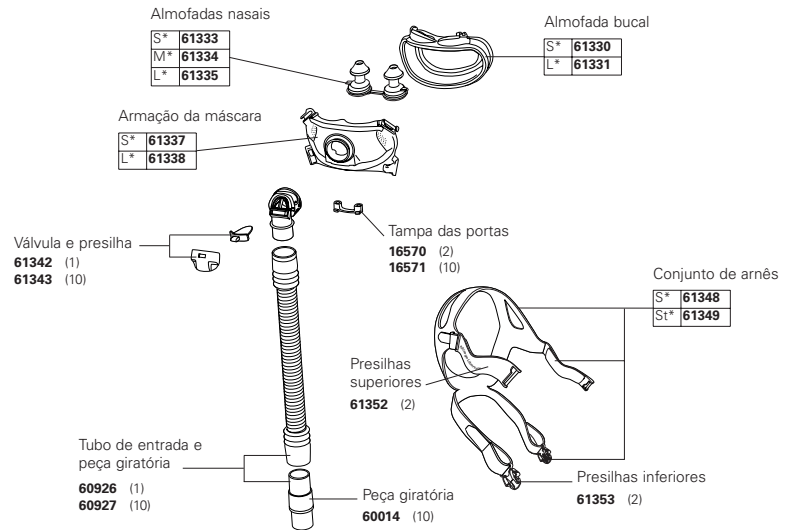

S\* Pequena M\* Média L\* Grande St\* Estándar

For details, refer to the *Mirage Liberty User Guide*. Specifications may change without notice. Mirage and Mirage Liberty are trademarks of ResMed Ltd and Mirage is registered in U.S. Patent and Trademark Office. © 2007 ResMed Ltd. 1011556/1 07 03