

TRANSCEND[®]

SLEEP WELL TONIGHT

CPAPXCHANGE

Transcend Heated Humidifier™ User Guide



Notices



Revised	Transcend Heated Humidifier User Guide 103404 Rev A Published April 15, 2013 and supersedes all previous versions.
Notice	The information contained in this document is subject to change without notice.
Trademark	Somnetics® and Transcend® are registered trademarks of Somnetics International, Inc.; all rights reserved.
Copyright	© Copyright 2013 Somnetics International, Inc.; all rights reserved.

Contact Somnetics International, Inc.

Corporate headquarters	Somnetics International, Inc.
Email	info@somnetics.com
Web	http://www.mytranscend.com/
Telephone	651.621.1800
Toll-free telephone	877.621.9626
Fax	651.204.0064



Somnetics International, Inc.
33 5th Avenue NW, Suite 500
New Brighton, Minnesota 55112 USA



Authorized Representative (MDD 93/42/EEC)
Methodize Europe
Driblad 11
NL-2811EG Reeuwijk
The Netherlands
Telephone +31 6 2129 41501

Introduction

Thank you for choosing the Transcend Heated Humidifier™ ('Humidifier'), designed to be used with Transcend positive airway pressure (PAP) therapy devices to humidify the air delivered during therapy. Dry air may cause nasal congestion or dryness of the nose, mouth, or throat during sleep apnea therapy, especially in dry or cold climates and in cases of air leakage through the mouth. Humidifying the air may help relieve these symptoms and make therapy more comfortable. Please read all instructions prior to use.

Intended use

The Transcend Heated Humidifier is indicated for the humidification of the air delivered from a compatible Transcend PAP therapy device. The Humidifier is intended for single patient re-use in the home and hospital/institutional environment. The Humidifier is for use only as recommended by a physician.

Contraindications

Please refer to the Transcend User Manual provided with your PAP device for contraindications associated with positive airway pressure therapy.

General warnings

Note: Specific warnings and cautions appear throughout the manual within relevant sections.

- Use the Humidifier only for its intended use as defined in this User Guide.
- Only use positive airway pressure devices, accessories, or parts recommended by Somnetics with the Humidifier.
- The Humidifier is for single patient re-use and must not be re-used on another person. This is to avoid the risk of cross-infection.
- Always place the Humidifier lower than the level of the patient. If it is placed at or above the level of the patient, heated water may flow down the air tubing and into the mask.
- Take care when handling the Humidifier. The water in the reservoir may be hot.
- If liquids are spilled on the Humidifier disconnect the power cord immediately, discontinue use, and contact your service provider.
- Do not modify this equipment without authorization of the manufacturer.
- The Humidifier Water Reservoir must be completely drained of water prior to transport. Water remaining in the Water Reservoir may leak during transport, damage the electrical circuitry of the device, and create a potential electrical shock hazard.

- Do not use the Humidifier in the presence of flammable or explosive materials.
- Medical electrical equipment including this device require special precautions regarding electromagnetic compatibility (EMC) and needs to be installed, placed, and used according to EMC information.
- Radiofrequency (RF) communications equipment can effect medical electrical equipment, including this device.
- Other cables and accessories may affect EMC performance.
- Be careful when placing or stacking this humidifier close to or on top of other equipment.

Symbols



Attention: consult accompanying documents



Type BF Applied Part

TYPE BF
ETL Classified



ETL Seal of Approval demonstrating quality, safety and professional manufacturing of medical product

Intertek



Upper and lower temperature limits

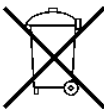

Separate collection for electrical and electronic equipment per EC Directive 2002/96/EC. – Waste Electrical and Electronic Equipment (WEEE)



Consult instructions for use



Upper and lower humidity limits

Non-condensing



Class II medical electrical equipment

Rx only

Caution: Federal Law (United States) restricts this device to sale by or on the order of a Physician.

Transcend Heated Humidifier Components

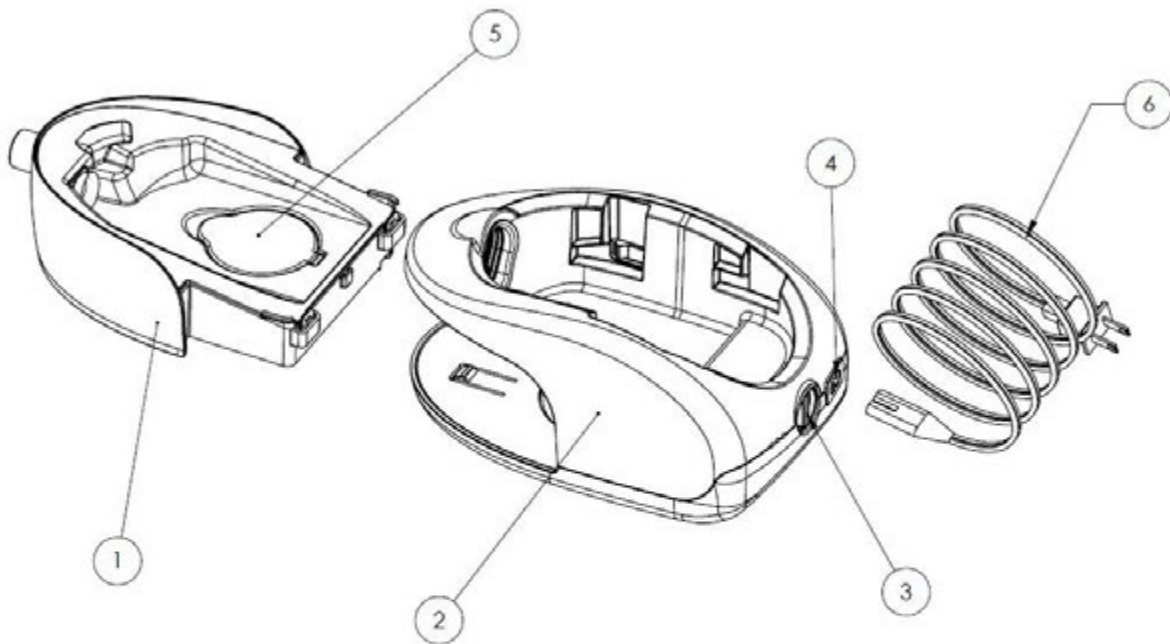

ITEM NUMBER	DESCRIPTION
1	WATER RESERVOIR
2	HUMIDIFIER BODY
3	SETTINGS KNOB
4	POWER INPUT
5	FILL CAP
6	2-PRONG POWER CORD

Using the Transcend Heated Humidifier

Please follow the sections below to set up, use, and clean your Humidifier.

Setting up your Humidifier

Place the Humidifier on a firm, level surface near your bed. It is recommended that the Humidifier not be placed on a surface that could be damaged by water. Place the Humidifier at a level that is lower than your sleeping position.

Caution: Do not position the Humidifier where it may be stepped on or accidentally overturned.

Filling the Water Reservoir

1. Remove the Water Reservoir by pulling it forward and out of the Humidifier Body (Image 1).
2. Pull up on the Fill Cap to open the Water Reservoir (Image 2).
3. Carefully fill the Water Reservoir with distilled water to the MAX fill line (Image 3).
4. Replace the Fill Cap ensuring it is tightly sealed.

Note: When carrying a filled Water Reservoir, ensure that the Fill Cap is sealed and the air outlet is tilted slightly upward. Take precaution not to tilt the air outlet at a downward angle as water may spill out of the reservoir.

5. Carefully re-insert the Water Reservoir into the Humidifier Body. You will hear an audible click and feel it lock into place when it is fully re-inserted.



Note: The base of the Humidifier Body has guides to help position the Humidifier Reservoir during reinsertion.

Caution: If the Water Reservoir is not correctly positioned and locked into place, the heater will not activate and the rightmost LED will turn red.

Warning: Disconnect power from the Humidifier prior to removing, filling, and replacing the Water Reservoir.

Warning: After use, take care when removing the Water Reservoir from the Humidifier as the water and the Water Reservoir may be hot.

Warning: Do not overfill the reservoir. Overfilling may allow water to enter the air supply tubing. Do not fill the reservoir above the indicated maximum fill level.

Warning: Re-insert the Water Reservoir slowly as water may spill into the air supply tubing if the Water Reservoir is not handled carefully.

Powering the Humidifier

The Humidifier is supplied with a power supply that connects to a wall outlet. This power source is for the Humidifier only.

The PAP device must be powered separately using any of the available Transcend power options described in the PAP device User Manual.

To power the Humidifier, plug the power supply cord into the back of the device, then connect the power supply to a wall (main) power outlet (Image 4).



Note: When looking at the back of the device, the leftmost LED will turn solid green indicating that the Humidifier has power.

Starting therapy

1. Connect one end of the air supply tubing onto the air outlet of the Humidifier. Connect the other end of the tubing to your mask (Image 5).

Note: Standard six foot air tubing is supplied with the Transcend Sleep Apnea



Starter System™. Air tubing is not included with the Humidifier.

2. Place the PAP device into the corresponding slots located at the top of the Humidifier; then slide the device forward until it snaps into place (Image 6).

Note: The Transcend PAP device has arm bars which help to guide it into the Humidifier port. You will hear an audible click and feel it lock into place when the PAP device is seated correctly.



3. Power the Transcend PAP device as described in the Transcend Sleep Apnea System User Manual. The PAP device may be powered via wall (main) power, Transcend battery, or Transcend Mobile Power Adaptor as appropriate.
4. Initiate therapy by pressing the power button (⏻) on the PAP device. Air flow from the PAP device will turn on the Humidifier automatically and it will begin warming the Water Reservoir. The middle LED on the back of the humidifier will turn solid green to indicate that the Humidifier is heating the Water Reservoir and is delivering humidification (Image 7).

Note: The Humidifier temperature setting must be in the range of 1 to 5 to initiate warming. A temperature setting of 0 will turn off the heating function of the Humidifier.



Note: The Humidifier will not begin warming the Water Reservoir until the PAP device power button has been pressed and the PAP device is in Therapy Mode. It may take up to 60 minutes to reach the set Humidifier temperature depending upon the selected heat setting.

Note: If a fault has occurred with the humidifier all three LEDs will begin to flash. Please refer to the troubleshooting section of this user manual for more information.

- Adjust the heat setting by using the dial located on the back of the Humidifier (Image 8).

Note: Heated humidification can be adjusted to a level of 0 to 5. The 0 setting will turn the heating function to 'off.' A setting of 5 provides the highest level of humidification. If a

heat setting has been recommended by your physician, begin at that setting and then adjust the dial up or down to reach your humidification comfort level.

Warning: Place the Humidifier at a level that is lower than your sleeping position to prevent condensation from collecting in air supply tubing and patient interface. Avoid using a heat setting that may result in the collection of condensation in the air tubing.



Ending therapy

- To stop therapy at any time, press the power button (⏻) on the Transcend PAP device (Image 9).

Note: It may take up to 60 seconds for the middle green LED to turn off.



Cleaning and maintenance

1. Unplug the Humidifier from the wall outlet and allow it to cool to the touch.
2. Remove the PAP device by pulling it rearward and sliding it out of the guide slots of the Humidifier (Image 10).

a. **Periodic Cleaning:** Clean the exterior of the Humidifier as needed. Use a mix of 5% mild liquid detergent in distilled water (1.6 fl oz. liquid detergent per quart of distilled water). This will clean away surface residue.

- Submerge a lint-free cotton cloth into the detergent solution.
- Wipe the exterior of the Humidifier using a gentle, back and forth wiping motion from the front to back of the Humidifier.
- Rinse the cloth in clear water to remove residual cleaning solution.
- Wring excess water from the cloth then wipe the Humidifier using a gentle front to back wiping motion to remove any detergent solution remaining on its surface.
- Wipe the device with a dry, lint-free cotton cloth until the device is fully dry.



b. **Daily Cleaning:** Clean the Water Reservoir daily by placing in the dishwasher or by immersing in a mixture of 5% mild liquid detergent in distilled water (1.6 fl oz. liquid detergent per quart of distilled water). For ease of cleaning, the Water Reservoir cover detaches by pushing on the tabs located at the back of the Water Reservoir and lifting the cover upward (Image 11).

For cleaning, follow the instructions below:

- For dishwasher cleaning, use standard dishwashing detergent with the dishwasher set in 'normal' setting.
- For hand cleaning, fully immerse the Water Reservoir in the cleaning solution.

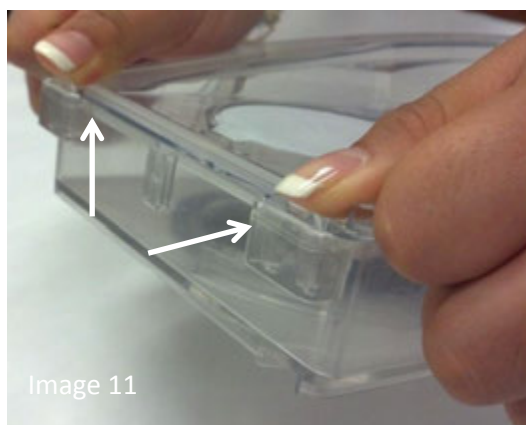

- While immersed, thoroughly wipe the surface with a lint-free cotton cloth. Apply firm pressure and ensure contact with all accessible contact surfaces to adequately remove soil buildup.
- Rinse by immersing in distilled water. Move the Water Reservoir in a back and forth motion for approximately 10 seconds to remove cleaning agent residue.
- Dry the Water Reservoir by wiping with dry, lint-free cotton cloth. Allow to air dry as needed.
- When cleaning is complete, replace the Water Reservoir cover by aligning the front tab into the reservoir base (Image 12).
- Guide the cover over the reservoir base. The tabs at the back of the base will flex outward and snap into place. An audible snap will be heard (Image 13).
- Carefully return the Water Reservoir to the Humidifier.

- c. **Weekly Maintenance:** Inspect the Water Reservoir and Fill Cap for wear and deterioration. If the Water Reservoir shows signs of leakage it should be replaced. Contact your home medical equipment provider or call Somnetics customer service at 1-877-621-9626 to purchase a replacement Water Reservoir.

Warning: To avoid the potential for electric shock unplug the Humidifier from the power source and remove the Transcend PAP device before cleaning the humidifier. Allow the Humidifier to dry completely before plugging it back into a power source.

Warning: The Water Reservoir is the only part of the Heated Humidifier that should be submerged in water. Never submerge any other part of the Humidifier in water.

Do not allow water to enter the interior of the Humidifier Body. In the event water enters the interior of the Humidifier Body, wipe the surfaces dry of water using a lint-free cotton cloth and allow to fully air dry before plugging it back in to a power source.



Reassembling the water reservoir

1. Reassemble the Reservoir cover by aligning the front tab into the Water Reservoir base (Image 14).
2. Guide the cover over the reservoir base. The tabs at the back of the base will flex outward until an audible snap is heard (Image 15).
3. Reinsert the Water Reservoir into the Humidifier Body as described.

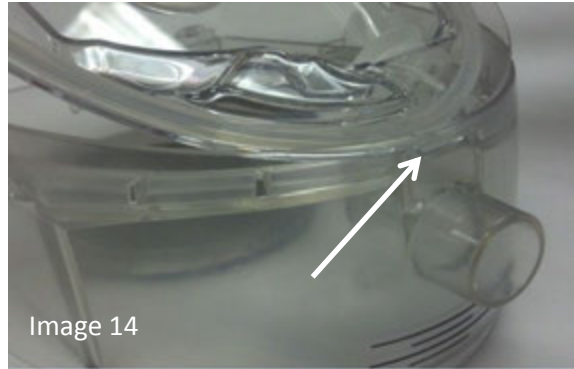

Image 14



Image 15

Servicing

No further maintenance is required. Do not open the Humidifier Body. There are no serviceable parts inside. Repairs and servicing should only be performed by a service agent authorized by the manufacturer.

Replacement Parts

Item	Part Number		Item	Part Number
Water Reservoir Assembly	503073		US 2-Prong Power Cord	503074
Transcend Heated Humidifier	503064		UK 2-Prong Power Cord	503076
EU 2-Prong Power Cord	503075		AU 2-Prong Power Cord	503077

Technical Specifications

Dimensions (LxWxH)	9 in x 5.5 in x 4.7 in
Weight	2.2 lbs (998g) empty; 3.1 lbs (1406g) with water to the max fill line.
AC Supply Input	100-240V, 50-60Hz
Water Reservoir Volume up to maximum fill level	325 mL
Working Pressure Range	4 to 20 cm H ₂ O
Warm up time	Up to 1 hour depending on heat setting

Caution: Humidity performance may be compromised if used outside the defined ambient temperature range and humidity range.

Inspiratory/Expiratory Pressure Drop:	0.375 cmH ₂ O @ 50 LPM (Liters per Minute)				
Gas Leakage of the Humidification System at max operating pressure:	4.85 LPM				
Humidifier Performance:	RH output %		Nominal system output (mg/L)		
		Setting 3	Setting 5	Setting 1	Setting 5
	4 cm H ₂ O	>90	>95	12	21
	12 cm H ₂ O	70	>75	14	14
20 cm H ₂ O	60	>65	10	15	
Maximum Gas Temperature:	77°F (25°C)				
Sound power level (@10 cmH ₂ O pressure, static)	37.0 dB (Transcend), 36.7 dB (Transcend EZEX, Transcend Auto)				
Sound pressure level (@10 cmH ₂ O pressure, static)	29.0 dB (Transcend), 28.7 dB (Transcend EZEX, Transcend Auto)				
Maximum heater plate temperature	131°F (55°C)				

Storage and Transport

Temperature Range	(-4)-140°F (-20-60°C)
Humidity Range	10-90% RH

Caution: Empty the water reservoir before traveling with the heated humidifier.

Operating Conditions

Ambient Temperature Range	41-95°F (5-35°C)
Gas Inlet Temperature Range	41-95°F (5-35°C)
Humidity Range	10-80% RH
Altitude	0-8000 ft.

Troubleshooting

Problem	Probable Cause	Solution
Humidifier does not turn on	Incorrect setup	<ol style="list-style-type: none"> 1. Ensure that you have the fully seated the PAP device into the Heated Humidifier and that you have pressed the PAP power button. 2. Be sure the PAP device and Heated Humidifier are connected to power.
Humidifier does not heat the Water Reservoir	Incorrect setup	<ol style="list-style-type: none"> 1. Ensure that you have followed the correct setup. The middle green LED will indicate that the Heated Humidifier is warming the Water Reservoir. It may take up to 45 seconds to reach the desired temperature.
PAP device turns on but then stops working	Massive air leak causing system to shut down	<ol style="list-style-type: none"> 1. Ensure that the air supply hose is fully connected to the Heated Humidifier and to your mask. 2. Securely fit the mask to your face before powering up the PAP device. . 3. Be sure the Water Reservoir gasket is in place and the Water Reservoir cover is fully seated. 4. Ensure the PAP device is fully seated in the Heated Humidifier.
The red LED is illuminated on the Humidifier	Water supply is low or water reservoir is detached from the humidifier.	<ol style="list-style-type: none"> 1. Ensure that the water reservoir is properly attached to the humidifier body. The reservoir has guides that will help to secure it in place. 2. Check the water supply inside of the water reservoir. If the water is low then the red LED will illuminate to signal a refill.
Water is splashing on your face	<p>The Water Reservoir is overfilled.</p> <p>The settings knob is set too high causing condensation to form in the air tube and mask.</p>	<ol style="list-style-type: none"> 1. Empty some water from the Water Reservoir. 2. Adjust the setting to a lower setting.

Air does not feel moist	The settings knob is set too low. The heater is not working.	<ol style="list-style-type: none"> 1. Adjust the setting to a higher setting. 2. If the problem persists, contact your home medical equipment provider or Somnetics customer service at 1-877-621-9626.
Air feels too moist	The settings knob is set too high.	<ol style="list-style-type: none"> 1. Adjust the setting to a lower setting.
Leaking Water Reservoir	Water Reservoir may be cracked or damaged. The lid may not be on correctly.	<ol style="list-style-type: none"> 1. Ensure that the reservoir cover is fully attached to the reservoir base. Refer to "reassembling the water reservoir" section. 2. Inspect the Water reservoir for damage or cracks. If there are signs of damage, contact your home medical equipment provider or Somnetics customer service at 1-877-621-9626 to order a replacement.
All three LEDs at the back of the Humidifier are flashing.	Humidifier is in a fault state.	<ol style="list-style-type: none"> 1. Unplug the Humidifier power supply. 2. Wait for 10 seconds. 3. Reattach the power supply to the Humidifier. If the problem continues contact your home medical equipment provider or Somnetics customer service at 1-877-621-9626.

Electromagnetic emissions

The Transcend Heated Humidifier is intended for use in the electromagnetic environment specified below. Ensure the Heated Humidifier is used in such an environment.

Emissions test	Compliance	Electromagnetic environment – guidance
RF radiated emissions CISPR11	Group 1	The Heated Humidifier system uses RF energy only for its internal function; therefore, its RF emissions are very low and are not likely to cause any interference in nearby electronic equipment.
RF conducted emissions CISPR 11	Class B	The Heated Humidifier system is suitable for use in all establishments and those directly connected to the public low-voltage power supply network that supplies buildings used for domestic purposes.
Harmonic emissions IEC 61000-3-2	Class A	
Voltage fluctuations/ flicker emissions	Complies	

IEC 61000-3-3		
---------------	--	--

Electromagnetic immunity

The Transcend Heated Humidifier is intended for use in the electromagnetic environment specified below. Ensure the Heated Humidifier is used in such an environment.

Immunity test	IEC 60601 test level	Compliance	Electromagnetic environment – guidance
Electrostatic discharge (ESD) IEC 61000-4-2	±2, 4, 6 kV contact ±8 kV air	N/A. The HH does not have conductive surfaces. ±2, 4, 6, 8 kV air	Floors should be wood, concrete, or ceramic tile. If floors are covered with synthetic material, the relative humidity should be at least 30%.
Electrical fast transient/burst IEC 61000-4-4	±2 kV for power supply lines ±1 kV for input/output lines	±2, kV for power supply lines ±1 kV for input/output lines	Line power quality should be that of a typical commercial or hospital environment.
Surge IEC 61000-4-5	±1 kV differential mode ±2 kV common mode	±0.5*, 1 kV differential mode ±2 kV common mode	Line power quality should be that of a typical commercial or hospital environment.

Immunity test	IEC 60601 test level	Compliance	Electromagnetic environment – guidance
Voltage dips, short interruptions, and voltage variations on power supply input lines IEC 61000-4-11	<5% U _T (>95% dip in U _T) for 0.5 cycle 40% U _T (60% dip in U _T) for 5 cycles 70% U _T (30% dip in U _T) for 25 cycles <5% U _T (>95% dip in U _T for 5 sec)	<5% U _T (>95% dip in U _T) for 0.5 cycle 40% U _T (60% dip in U _T) for 5 cycles 70% U _T (30% dip in U _T) for 25 cycles <5% U _T (>95% dip in U _T for 5 sec)	Line power quality should be that of a typical commercial or hospital environment. If the user of the CPAP system requires continued operation during power line interruptions, it is recommended that the CPAP system be powered from the battery. Note U _T is the A.C. line voltage before application of the test level.
Power frequency (50/60 Hz) magnetic field IEC 61000-4-8	3 A/m	3 A/m	Power frequency magnetic fields should be at levels characteristic of a typical commercial or hospital environment.
Conducted RF IEC 61000-4-6	3 Vrms 150 kHz to 80 MHz	3 Vrms 10 KHz to 100 MHz*	Recommended separation distance: $d = 1.17 \sqrt{P}$

Immunity test	IEC 60601 test level	Compliance	Electromagnetic environment – guidance
Radiated RF IEC 61000-4-3	3 V/m 80 MHz to 2.5 GHz	10 V/m (compliance level adjusted to meet FDA limits) 26 MHz to 2.5 GHz Note At 80 MHz and 800 MHz, the higher frequency range applies.	Recommended separation distance: $d = 0.35 \sqrt{P}$ 80 MHz to 800MHz Recommended separation distance: $d = 0.70 \sqrt{P}$ 800MHz to 2.5 GHz where P is the maximum output power rating of the transmitter in watts (W) according to the transmitter manufacturer and d is the recommended separation distance in meters (m). Field strengths from fixed RF transmitters, as determined by an electromagnetic site survey ¹ , should be less than the compliance level in each frequency range ² . Interference may occur in the vicinity of equipment marked with the following symbol: 

¹ Field strengths from fixed transmitters, such as base stations for radio (cellular/cordless) telephones and land mobile radios, amateur radio, AM and FM radio broadcast and TV broadcast cannot be predicted theoretically with accuracy. To assess the electromagnetic environment due to fixed RF transmitters, an electromagnetic site survey should be considered. If the measured field strength in the location in which the humidifier system is used exceeds the applicable RF compliance level above, the humidifier system should be observed to verify normal operation. If abnormal performance is observed, additional measures may be necessary, such as reorienting or relocating the system.

² Over the frequency range 150 kHz to 80 MHz, field strengths should be less than 3 V/m.

EN 60601-1 compliance

Protection against electric shock:	Class II
Degree of protection against ingress of water:	Type BF IP22

Warranty

Somnetics warrants the Transcend Heated Humidifier to be free of defects in materials and workmanship and will perform in accordance with the product specifications for a period of 2 years from the date of sales by Somnetics to the dealer.

If the product fails to perform in accordance with the product specifications, Somnetics will repair or replace, at its option, any materials or parts of the Heated Humidifier, which, upon Somnetics' examination appear defective. This does not cover damages caused by accident, misuse, abuse, alteration, and other defects not related to material or workmanship. Somnetics will pay customary freight charges from Somnetics to dealer location only.

Somnetics disclaims all liability for economic loss, loss of profits, overhead, or consequential damages which may be claimed to arise from any sale or use of this product. Some states do not allow the exclusion or limitation of incidental or consequential damages, so the above limitation or exclusion may not apply to you.

This warranty is given in lieu of all other express warranties. In addition, any implied warranties, including warranty of merchantability or fitness for the particular purpose are limited to two years. Some states do not allow the exclusion or limitation of incidental or consequential damages, so the above limitation or exclusion may not apply to you. This warranty gives you specific legal rights, and you may also have rights which vary from state to state.

To qualify for repair, replacement, or refund, the defective device must be returned to Somnetics within 30 days after the discovery of the defect. Any repair, replacement, or refund obligation would not apply if the device has been repaired or otherwise altered in a facility not authorized in writing by Somnetics To exercise your rights under this warranty, contact your local, authorized Somnetics dealer or Somnetics at 33 5th Avenue, New Brighton, Minnesota 55112 USA, 1.877.621.9626 or 1.651.621.1800

Somnetics International, Inc.
33 5th Avenue NW, Suite 500
New Brighton, Minnesota 55112 USA

<http://www.mytranscend.com/>

Phone: 651.621.1800

Toll-free: 877.621.9626

Fax: 651.204.0064

Transcend Heated Humidifier User Guide **REF** 103404 Rev A